

# MH3 User Guide





**IMPORTANT**  
Please read this manual carefully before using  
your mixer for the first time.

© Harman International Industries Ltd. 2003

All rights reserved

Parts of the design of this product may be protected by worldwide patents.

Part No. ZM0278

Issue: Preliminary 8/1/03

Soundcraft is a trading division of Harman International Industries Ltd. Information in this manual is subject to change without notice and does not represent a commitment on the part of the vendor. Soundcraft shall not be liable for any loss or damage whatsoever arising from the use of information or any error contained in this manual.

No part of this manual may be reproduced, stored in a retrieval system, or transmitted, in any form or by any means, electronic, electrical, mechanical, optical, chemical, including photocopying and recording, for any purpose without the express written permission of Soundcraft.



Harman International Industries Limited  
Cranborne House  
Cranborne Road  
POTTERS BAR  
Hertfordshire  
EN6 3JN  
UK

Tel: +44 (0)1707 665000  
Fax: +44 (0)1707 660742  
<http://www.soundcraft.com>

# Introduction

# Key Features

- Versatile design allows FOH, Monitors, or Monitors from FOH
- Semi-modular for flexible layouts and easy serviceability
- Frame sizes 24 mono/4 stereo, 32 mono/4 stereo, 40 mono/4 stereo, 48 mono/4 stereo, 56 mono/4 stereo
- Flexible Auxiliary Bus structure with 2 stereo sends for in-ear monitoring
- 8 group busses and 12 aux busses in FOH mode
- 12 monitor busses (8 mono, 2 stereo) in Monitor mode
- Swap mode allows fader control of Aux outputs in Monitor mode
- Integral 12x4 matrix, can be expanded to 12x8 with optional matrix module
- 3-band EQ on FX returns 1-8, can be flipped into output fader path
- New Mic Amp design with high headroom and outstanding CMRR
- New EQ design with focused response
- LCR panning on inputs
- 8 VCA groups and 8 Mute groups with snapshot automation and MIDI control
- Integrated control of BSS Audio Varicurve™ and dbx DriveRack™
- Integral LED bargraph metering for all inputs and outputs
- Optional VU output meterbridge

## Warranty

- 1 Soundcraft is a trading division of Harman International Industries Ltd.  
End User means the person who first puts the equipment into regular operation.  
Dealer means the person other than Soundcraft (if any) from whom the End User purchased the Equipment, provided such a person is authorised for this purpose by Soundcraft or its accredited Distributor.  
Equipment means the equipment supplied with this manual.
- 2 If within the period of twelve months from the date of delivery of the Equipment to the End User it shall prove defective by reason only of faulty materials and/or workmanship to such an extent that the effectiveness and/or usability thereof is materially affected the Equipment or the defective component should be returned to the Dealer or to Soundcraft and subject to the following conditions the Dealer or Soundcraft will repair or replace the defective components. Any components replaced will become the property of Soundcraft.
- 3 Any Equipment or component returned will be at the risk of the End User whilst in transit (both to and from the Dealer or Soundcraft) and postage must be prepaid.
- 4 This warranty shall only be available if:
  - a) the Equipment has been properly installed in accordance with instructions contained in Soundcraft's manual; and
  - b) the End User has notified Soundcraft or the Dealer within 14 days of the defect appearing; and
  - c) no persons other than authorised representatives of Soundcraft or the Dealer have effected any replacement of parts maintenance adjustments or repairs to the Equipment; and
  - d) the End User has used the Equipment only for such purposes as Soundcraft recommends, with only such operating supplies as meet Soundcraft's specifications and otherwise in all respects in accordance Soundcraft's recommendations.
- 5 Defects arising as a result of the following are not covered by this Warranty: faulty or negligent handling, chemical or electro-chemical or electrical influences, accidental damage, Acts of God, neglect, deficiency in electrical power, air-conditioning or humidity control.
6. The benefit of this Warranty may not be assigned by the End User.
7. End Users who are consumers should note their rights under this Warranty are in addition to and do not affect any other rights to which they may be entitled against the seller of the Equipment.



# Installation

# Dimensions and Configurations

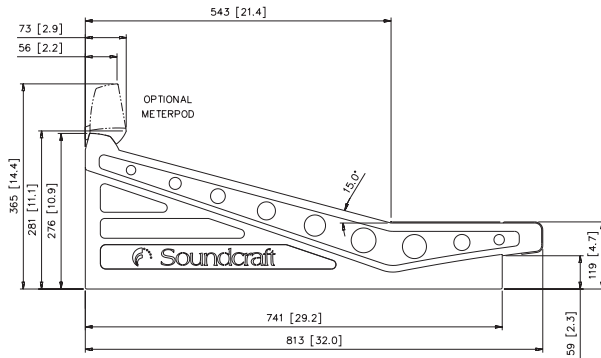

CONSOLE	OVERALL WIDTH mm [inches]
24CH	1419 [55.8]
32CH	1683 [66.2]
40CH	1947 [76.6]
48CH	2211 [87.0]
56CH	2475 [97.4]

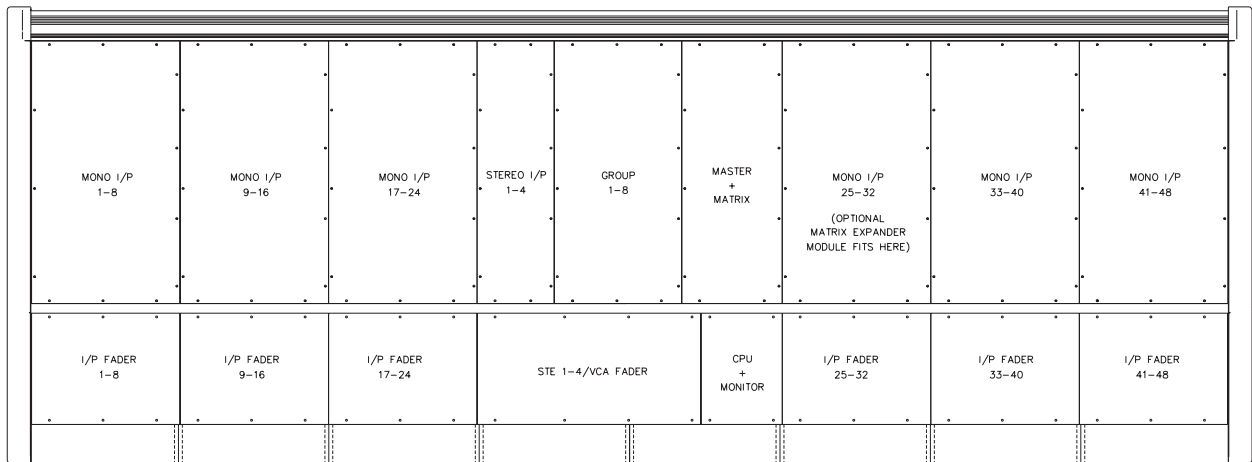
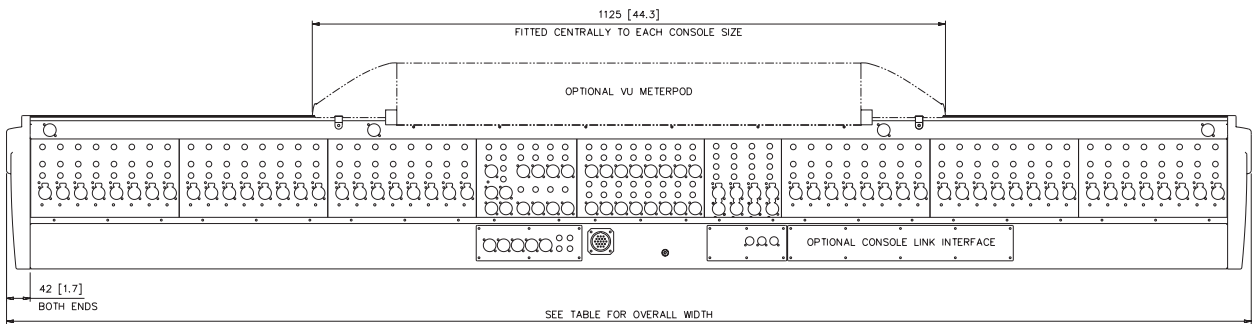

# Precautions and Safety Instructions

## General Precautions

Avoid storing or using the mixing console in conditions of excessive heat or cold, or in positions where it is likely to be subject to vibration, dust or moisture. Do not use any liquids to clean the fascia of the unit: a soft dry brush is ideal. Use only water or ethyl alcohol to clean the trim and scribble strips. Other solvents may cause damage to paint or plastic parts.

Avoid using the console close to strong sources of electromagnetic radiation (e.g. video monitors, high-power electric cabling): this may cause degradation of the audio quality due to induced voltages in connecting leads and chassis. For the same reason, always site the power supply away from the unit.

**Caution! In all cases, refer servicing to qualified personnel.**

## Handling and Transport

The console is supplied in a strong carton. If it is necessary to move it any distance after installation it is recommended that this packing is used to protect it. Be sure to disconnect all cabling before moving. If the console is to be regularly moved we recommend that it is installed in a foam lined flightcase. At all times avoid applying excessive force to any knobs, switches or connectors.

## Power Supplies & Cables

Always use the power supply and cable supplied with the mixer: the use of alternative supplies may cause damage and voids the warranty; the extension of power cables may result in malfunction of the mixing console.

**W a r n i n g ! Always switch the power supply off before connecting or disconnecting the mixer power cable, removing or installing modules, and servicing. In the event of an electrical storm, or large mains voltage fluctuations, immediately switch off the PSU and unplug from the mains.**

**W a r n i n g ! Always ensure that you use the correct PSU (CPS800) for your mixer.**

## Signal Levels

It is important to supply the correct input levels to the console, otherwise signal to noise ratio or distortion performance may be degraded; and in extreme cases, damage to the internal circuitry may result. Likewise, on all balanced inputs avoid sources with large common mode DC, AC or RF voltages, as these will reduce the available signal range on the inputs. Note that  $OdBu = 0.775V \text{ RMS}$ .

Refer to the Specifications section for details of input and output levels.

# Mains Installation

## General Wiring Procedures

To take full advantage of the excellent signal to noise ratio and low distortion of Soundcraft consoles, care must be taken to ensure that incorrect installation and wiring does not degrade the performance of the desk. Hum, buzz, instability and Radio Frequency interference can usually be traced to earth loops and inferior earthing systems. In some areas, especially heavily industrial areas, the incoming mains earth will not be adequate and a separate technical earth for all the audio equipment must be supplied. However, check with your local electricity supply company to ensure that safety regulations are not infringed or negated.

The successful, hum free, installation of a system requires forethought, and the establishment of a set of ground rules, which must be consistently adhered to at all stages of installation.

## Initial Wiring Considerations

For optimum performance, it is essential for the earthing system to be clean and noise free, as all signals are referenced to this earth. A central point should be decided on for the main earth point system, and all earths should be 'star fed' from this point. It is common electrical practice to 'daisy chain' the earths to all electrical outlets but this method is unsuitable for audio installations. The preferred method is to run an individual earth wire from each outlet, back to the system star point to provide a safety earth screen reference for each piece of equipment. A separate earth wire should also be run from each equipment rack and area, to the star point. This may or may not be used depending on circumstances, but it is easier to install in the first place, than later when problems arise. The location of the star point should be a convenient, easily accessible place, preferably at the rear of the console or in the main equipment rack.

Install separate 'clean' and 'dirty' mains outlets, wired individually back to the incoming mains distribution box. Use the 'clean' supply for all audio equipment and the 'dirty' supply for all lighting, etc. Never mix the two systems.

If necessary, to provide sufficient isolation from mains borne interference, install an isolating transformer. This should be provided with a Faraday Shield which must be connected with earth.

Never locate the incoming mains distribution box near audio equipment, especially tape recorders, which are very sensitive to electro-magnetic fields.

Ensure that all equipment racks are connected to earth, via a separate wire back to the star point.

Equipment which has unbalanced inputs and outputs may need to be isolated from the rack to prevent earth loops.

## Audio Wiring

Having provided all equipment with power and earthing connections, consideration must be given to the method of providing audio interconnection and adequate screening of those interconnections. This must be done in a logical sequence to avoid problems and assist in the localisation of problem equipment.

Connect the FOH or Monitor system to the console and check for any hum, buzz, or RFI. Only when you are satisfied with the quietness of the console and the PA system should you proceed with the next step.

Connect stereo or multitrack tape recorders, FX and foldback sends one at a time, checking and isolating any connection which degrades performance.

Connect all other peripheral devices.

Connect all microphone lines.

By following this sequence much time and future trouble will be saved, and the result will be a quiet, stable system.

## Shielding

Audio equipment is supplied with a variety of input and output configurations, which must be taken into consideration when deciding where the screen connections should be made. There are three sources of unwanted signal being impressed on the screen, which are as follows:

Extraneous electrostatic or electromagnetic fields.

Noise and interference on the earth line.

Capacitive coupling between the screen and signal wires.

To minimise the adverse affects of the unwanted coupling to the signal wires, it is important that the screen is connected at one end only, i.e. the screen must not carry any signal) current. Any signal) on the wires within the screen will be capacitively coupled to the screen. This current will ultimately be returned to the source of the signal, either directly, if the screen is connected at the signal source end, or indirectly via the earthing system, if the signal is connected at the signal destination end. The indirect connection will cause an increase in high frequency cross-talk, and should be avoided wherever possible.

Therefore, in general, always connect the shield only at the signal source end. In high RF areas, the screen can also be connected to earth via a 0.01 mF capacitor. This will present a short circuit at RF frequencies, thus lowering the effective shield impedance to ground. However, at low audio frequencies the reactance of the capacitor will be sufficiently high not to cause an earth loop problem.

## Points to Remember

In all cases, use good quality twin screened audio cable. Check for instability at the output.

Always connect both conductors at both ends, and ensure that the screen is only connected at one end.

Do not disconnect the mains earth from each piece of equipment. This is needed to provide both safety and screen returns to the system star point.

Equipment which has balanced inputs and outputs may need to be electrically isolated from the equipment rack and/or other equipment, to avoid earth loops.

It is important to remember that all equipment which is connected to the mains is a potential source of hum and interference and may radiate both electrostatic or electromagnetic radiation. In addition, the mains will also act as a carrier for many forms of RF interference generated by electric motors, air-conditioning units, thyristor light dimmers etc. Unless the earth system is clean, all attempts to improve hum noise levels will be futile. In extreme cases there will be no alternative but to provide a completely separate and independent `technical earth' to replace the incoming 'noisy earth'. However, always consult your local electricity supply authority to ensure that safety regulations are not being infringed.

# Connections

## Audio Connectors

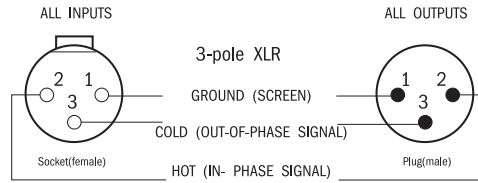

1/4" Stereo Jack Plug used as balanced Input/Output:  
All Jacks Except Headphones

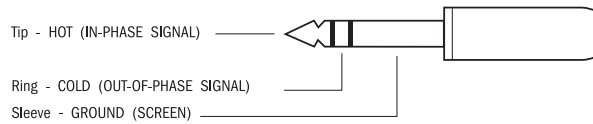

1/4" Stereo Jack Plug used For Headphones

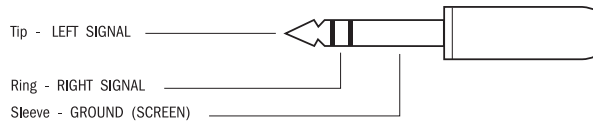

## Lamp Connectors

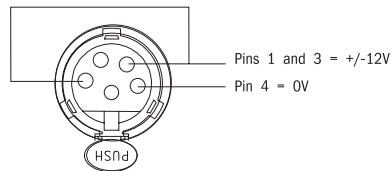

## MIDI Connectors

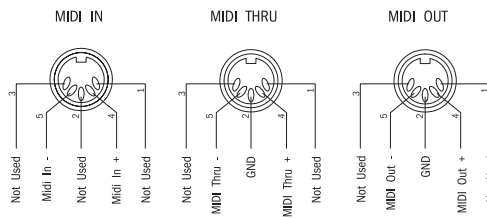

The MIDI IN signal is buffered by an opto-isolator.

# BLOCK DIAGRAMS



# Stereo Input Module

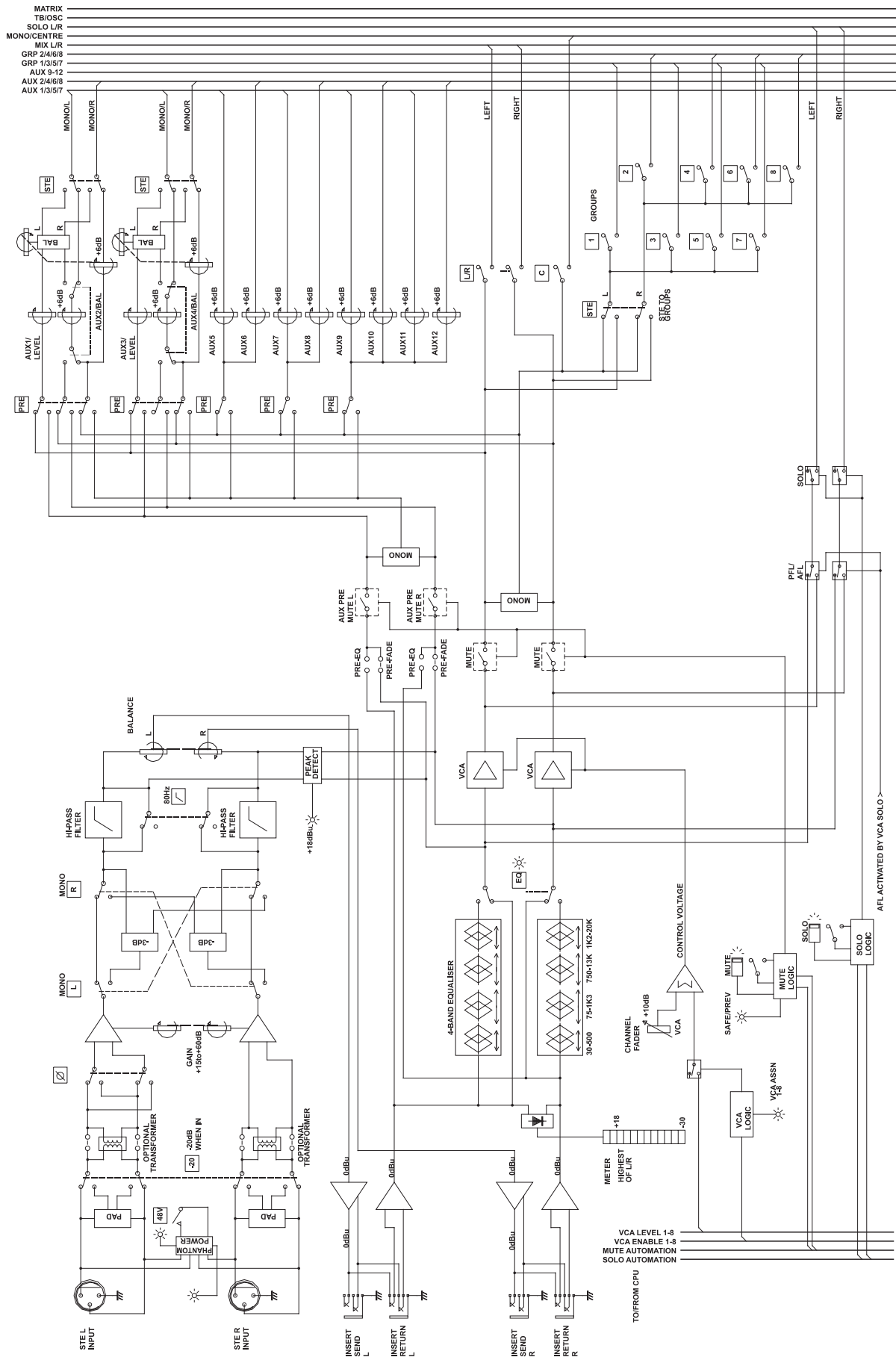

# Group/Aux/FX Master

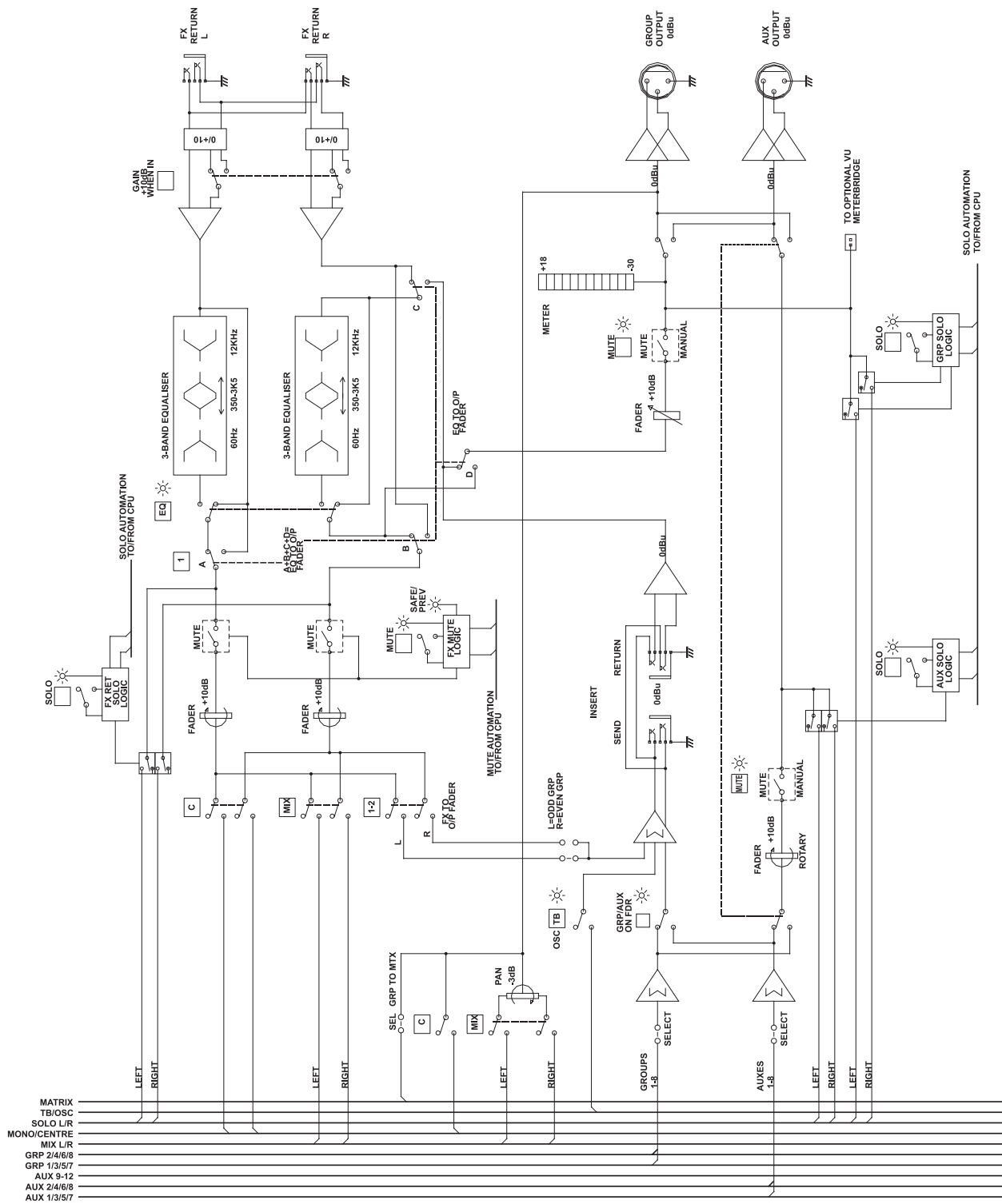

# Aux/Matrix Master

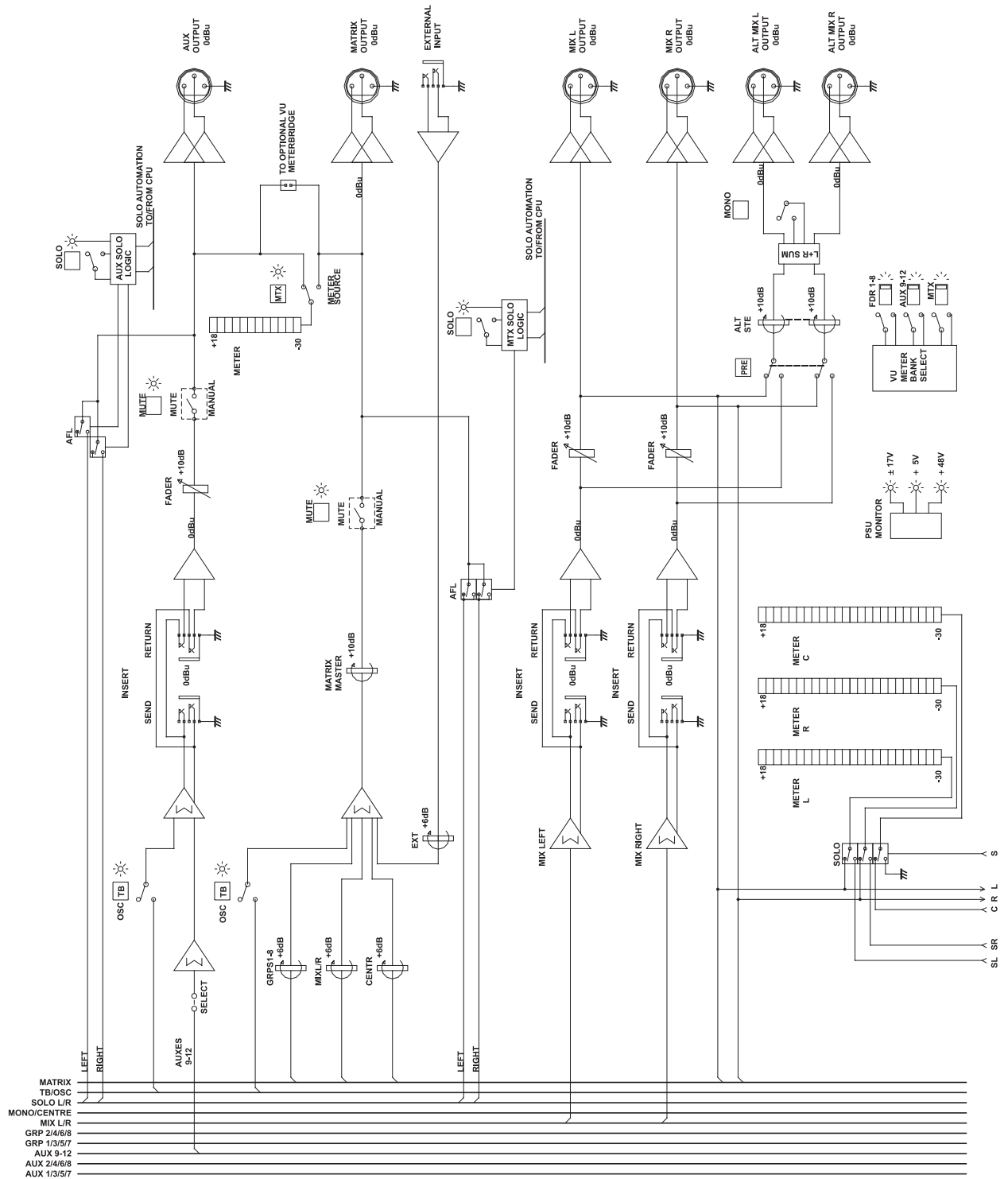

# Monitor

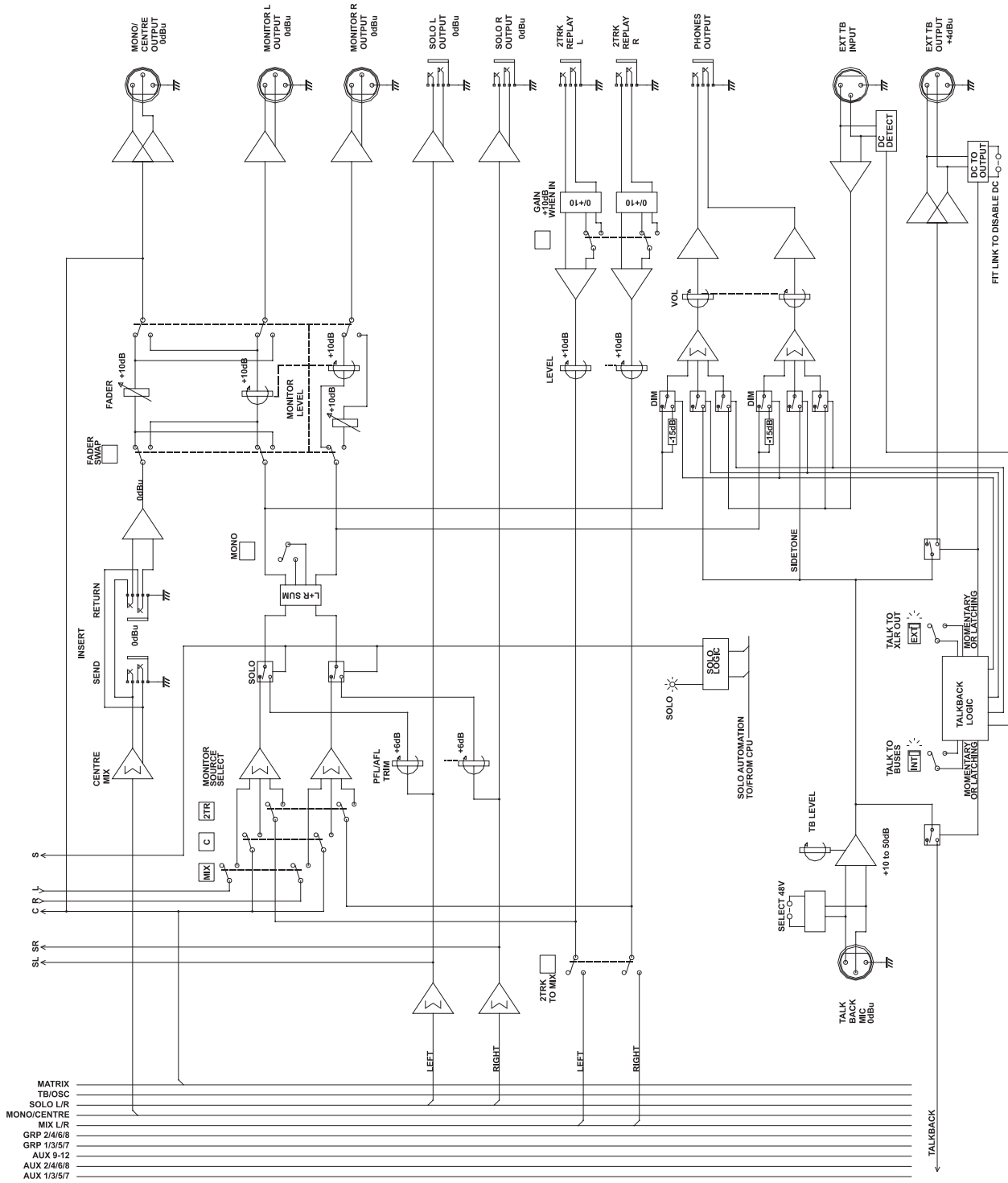

# VCA/CPU

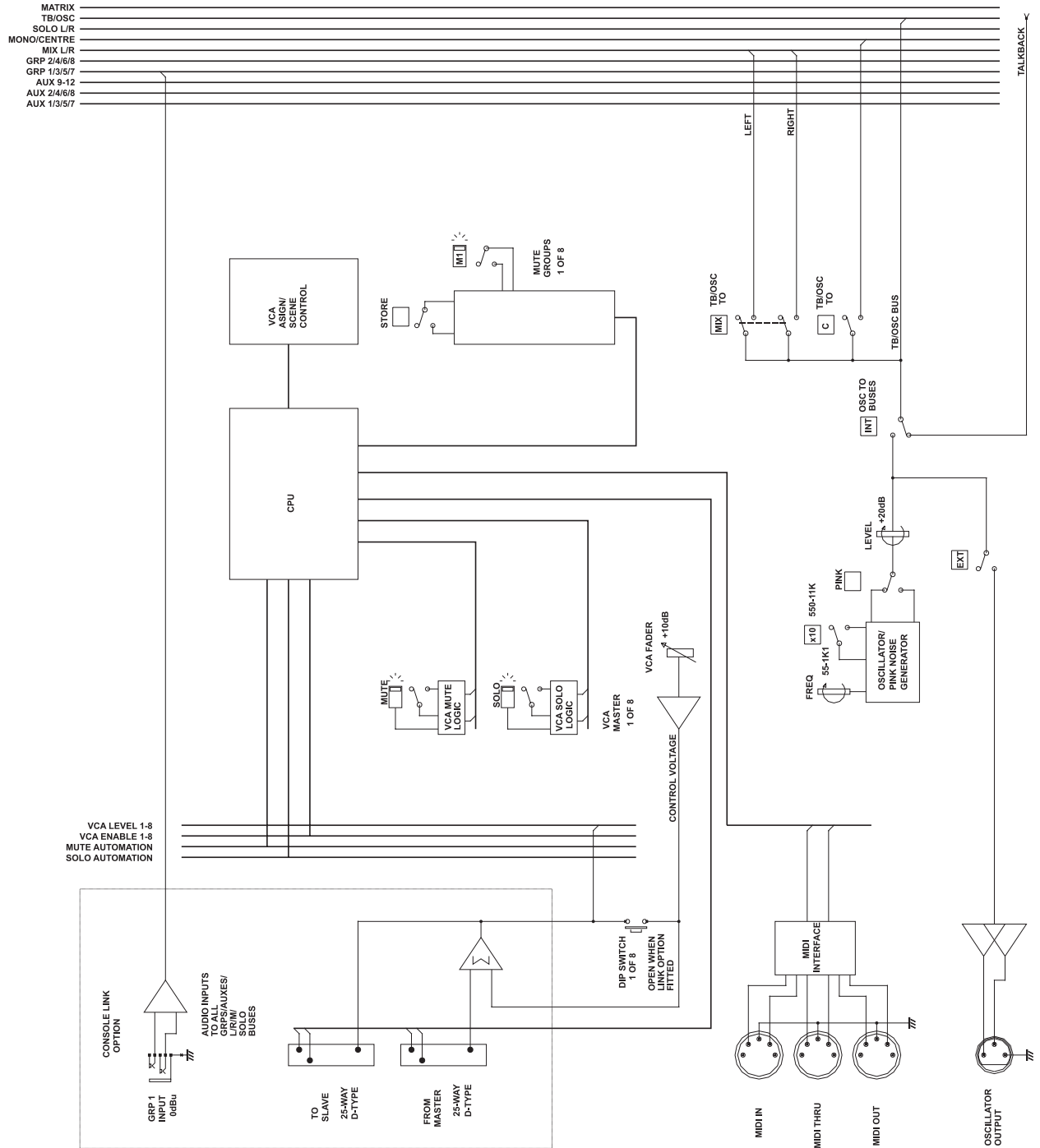



# Console Operation

# Mono Input Module

Mono inputs are modular in blocks of 8 channels, and feature an integral rear connector panel.

## Pre-Amp

The module's pre-amp features a high headroom and outstanding CMRR performance. The XLR input can handle signals up to +26dBu, with a gain range of +15dBu to +60dBu (1) and a 20dB gain change switch (2). A Peak LED (3) indicates internal signal levels in excess of +18dBu. This monitors both the pre-amp output and the EQ section output. Polarity Reverse (4) and Phantom Power switching (5) is provided, with both front (6) and rear panel indication of phantom power status. Note: the 48V LEDs do NOT auto sense the presence of external phantom power, as on the MH4.

## Balanced Insert Point

Separate jacks provide a pre-EQ balanced send and return, at a nominal level of 0dBu. See the rear panel connectors.

## EQ and HI-PASS Filter

This new design retains the traditional Soundcraft response, but incorporates steeper slopes on the HF stage focussing the control where you want it, and some carefully tailored overshoot on the LF band, which automatically controls the muddy lower-mid frequencies when boosting lows.

The high-pass filter (7) is variable from 30Hz - 400Hz with bypass (8) if required. The EQ section may be bypassed by releasing the EQ switch (9).

The EQ section is four band, with shelving sweep high and low frequency sections, and fully parametric high-mid and low-mid bands. The frequency ranges are 30Hz-500Hz (LF)(10), 75Hz-1.3kHz (Low Mid)(11), 750Hz-13kHz (High Mid)(12), and 1.2kHz-20kHz (HF)(13), with +/- 15dB of cut or boost available at any frequency. The Q is variable on the two mid bands from 0.5 to 3.

## Aux Sends

There are 12 Aux sends (14), which can be used either as FX sends in FOH use, or monitor mixes for monitoring. Aux 1 & 2 and 3 & 4 can be switched to stereo pairs for in-ear sends, using the adjacent colour-coded STE switches (15). Each send has 5dB of gain at maximum.

The Auxes can be switched Pre- or Post-fader by the adjacent PRE switches (16), which are in pairs for the first 8 sends, and as one group for Aux 9-12. The default Pre-fade signal for all Auxes is pre-EQ but can be changed to post-EQ via internal links (both feeds follow the channel mute).

## Subgroup Routing

In addition to the 12 Aux sends, 8 busses are provided for conventional subgrouping. Routing to these is via 8 individual routing switches (17). The PAN to Groups switch (18) allows any odd/even pair of group busses to follow the channel pan pot as a stereo pair.

## Direct Output

A direct output on balanced 1/4" jack is available from the channel, see the rear connector panel. The source is controlled by the DIR switch (19), which switches the direct output from pre-EQ to post-fade when the switch is pressed in. In addition, there are internal solder links to alter the signal feeds in both of the switch positions, as follows:

- DIR switch not pressed - pre-EQ (default) OR pre-filter
- DIR switch pressed - post-fade (default) OR post-EQ

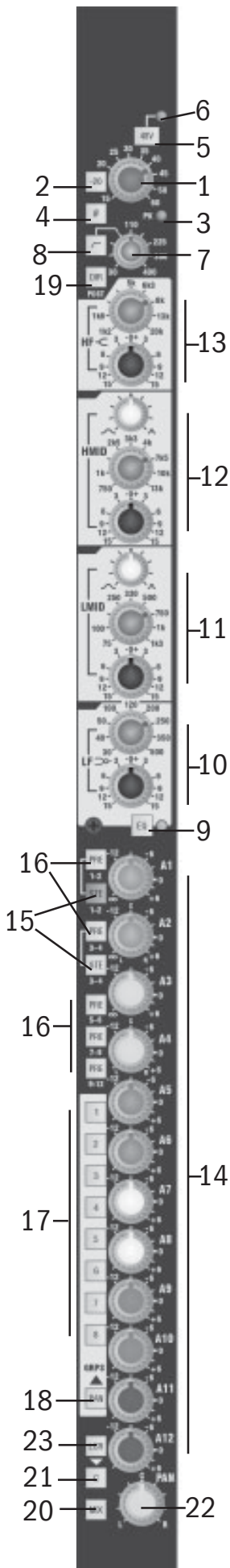

## Mix Bus Routing and Pan controls

The signal is sent to the stereo mix bus and the mono (C) bus using the MIX (20) and C (21) switches. The PAN control (22), which gives 3dB centre drop, operates on the stereo mix bus signal, unless LCR panning is engaged.

When routed the Mono (C) bus is always fed directly with the post-fader signal, unless LCR panning is engaged.

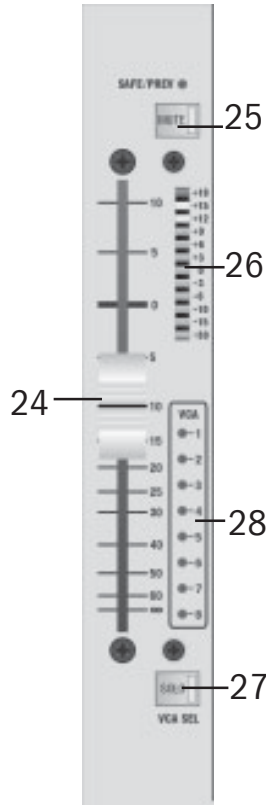

### LCR Panning

The LCR switch (23) changes the mode of the Pan pot from normal left - right panning with a 3dB centre drop, to 3-way LCR panning, requiring both the mono (C) bus and stereo mix bus to be routed, and the pan pot panning from left to C, and C to right. When the pot is physically centred, there is no output from the left and right mix bus outputs.

### Fader

A high-quality long-throw 100mm fader (24) controls the level to all busses, and has 10dB of gain when fully up as well as an expanded scale around the critical unity gain area for maximum resolution.

### MUTE

The MUTE switch (25) mutes the signal to all busses, including pre-fade Aux sends. The mute circuit can also be activated by the mute group system, a SIP mute signal, a VCA mute signal or internal snapshot control from the scene computer. A Preview mode allows editing and checking of mute groups and snapshots without disturbing the audio passing through the desk, and Mutes can be set 'Safe'.

### SAFE/PREV LED

The SAFE/PREV LED is used to indicate the Mute Safe status of the channel or Preview mute status, if the console is in Preview mode. The channel is toggled in or out of SAFE mode using the MUTE switch, after first engaging EDIT SAFES mode on the master CPU panel. Steady illumination of the LED indicates a mute safe condition. Preview status is indicated by flashing illumination, upon entering Preview mode from the master module, if the Mute is present in the previewed mute group or scene.

### LED Input Metering

Every channel is fitted with a 12-segment LED bargraph meter (26), positioned next to each fader for maximum visibility and giving immediate graphic indication of incoming signals at the insert return.

### VCA Assign LEDs

The module is assigned to the 8 VCA Groups using the SOLO button (27) on each channel, in conjunction with the VCA Master SOLO switches. The whole console has to be switched into the VCA Assign Mode (press the "VCA Assign Mode" switch located at the top of the master cpu panel) in order for the SOLO switch functions to be changed in this way. The current VCA assignments are indicated on the 8 VCA Assign LEDs (28) adjacent to the fader.

### SOLO

The Solo button provides a PFL feed to the engineer's headphones or monitors, or triggers a destructive solo in place, depending on mode selection at the master section. The solo button can also be activated remotely from a VCA solo when assigned to a VCA group, giving Stereo AFL. Intercancel or additive soloing is possible, with or without input priority, and solos can be cleared with a single button press at the master section. The solo buttons also feature automatic momentary operation, by pressing and holding for more than 0.5sec.

## Mono Input Rear Connector Panel



### INPUT (3 pin female XLR)

Pin 1	Ground
Pin 2	Signal Hot
Pin 3	Signal Cold

### INSERT SEND (1/4" TRS Jack)

Tip	Signal Hot
Ring	Signal Cold
Sleeve	Ground

### INSERT RETURN (1/4" TRS Jack)

Tip	Signal Hot
Ring	Signal Cold
Sleeve	Ground

### DIR O/P ((1/4" TRS Jack)

Tip	Signal Hot
Ring	Signal Cold
Sleeve	Ground

Note: the small hole in the rear panel below the Input XLR is to allow factory adjustment of the module's internal VCA element. No further adjustment of this is required or should be attempted, unless the VCA element is replaced during servicing.

## Solder Link Options

The MH3 contains some optional links which allow certain internal signal feeds to be changed to suit user preference. For maximum reliability these are solder links, rather than push-on jumpers, in most cases.

Each link has its function identified by text on the pcb.

To change the default setting it is necessary to remove a zero-ohm resistor which sets the default routing, and then create a solder bridge between the relevant pair of solder pads. Once the resistor is removed it can be discarded. A second pair of solder pads adjacent to the resistor allows the default setting to be restored if required.

Function	Options	Default
Aux PRE source	muted pre or post-EQ, or pre-insert	muted pre-insert (R218)
Direct source (DIR switch up)	Pre-EQ or pre-filter (both non-muted)	Pre-EQ (R217)
Direct source (DIR switch down)	Post-fade or post-EQ	Post-fade (R212)

# Stereo Input Module

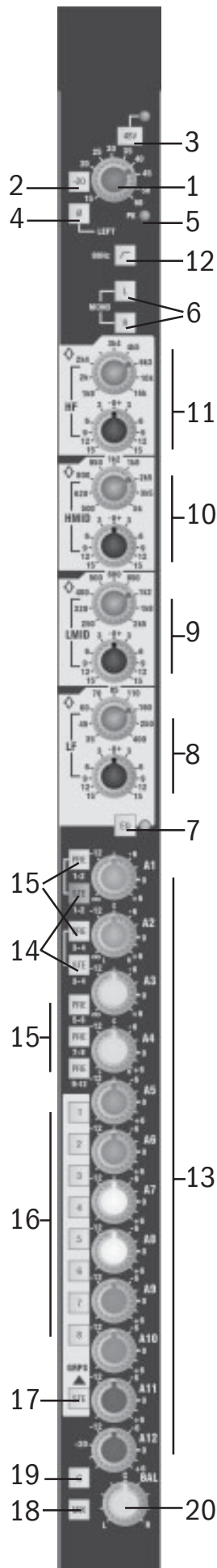

## Input stage

A stereo version of the Mono input's high performance pre-amp offers the same gain range of +15dBu to +60dBu (1) and a 20dB gain change switch (2). It also has Phantom Power switching (3), and polarity reverse on the left channel (4). The peak LED (5) indicates signals in excess of +18dBu on either left or right channels, while two MONO switches (6) cut either Left or Right channel, feeding the alternate channel to both module paths, or if both are pressed, a mono sum of L and R to the module paths.

## Balanced Insert Points with INS switch

Separate jacks provide a pre-EQ balanced send and return, for Left and Right channels, at a nominal level of 0dBu. See the rear connector panel.

## EQ and HI-PASS Filter

The EQ section is stereo four band, with sweepable frequencies on all bands and is enabled by pressing the EQ switch (7).

The frequency ranges are 35Hz-400Hz (LF)(8), 250Hz-2.5kHz (Low Mid)(9), 500Hz-5kHz (High Mid)(10), and 1.8kHz-16kHz (HF)(11), with  $\pm 15$ dB of cut or boost available at any frequency. The Q is fixed on all bands at 1.1.

The stereo High-pass filter is fixed at 80Hz, and is switched in with the High-pass switch (12).

## Aux Sends

As on the mono input there are 12 sends (13), for FX or Monitor use.

Aux 1 & 2 and 3&4 can be switched to stereo pairs for in-ear sends, using the adjacent STE switches (14), colour-coded to match the relevant send knob. In this case, the A1 knob becomes a stereo Level control, and the A2 knob becomes the PAN between Aux 1 and Aux 2. Similarly for Aux 3 & 4.

Each send has 5dB of gain at maximum, and is always fed from a mono sum of the left and right signals. ( If Aux 1 & 2 or Aux 3 & 4 are switched to stereo, these sends are fed with a stereo signal, left to Aux 1/3 and right to Aux 2/4.)

The Auxes can be switched Pre- or Post-fader by the adjacent PRE switches (15), which are in pairs for the first 8 sends, and as one group for Aux 9-12. The default Pre-fade signal for all Auxes is pre-EQ but can be changed to post-EQ via internal links (both feeds follow the channel mute).

## Subgroup Routing

In addition to the 12 Aux sends, 8 busses are provided for conventional subgrouping.

Routing to these is via 8 individual routing switches (16). Normally the Group switches are fed by a mono sum of left and right signals, but the STE switch (17) allows any odd/even pair of group busses to be used as a stereo pair, following the channel's Balance control.

## Mix Bus Routing and Balance controls

The signal is sent to the stereo mix bus and the mono bus using the MIX (18) and C (19) switches.

The BAL (20) control allows the left signal to be faded down to zero level when turned fully clockwise, and vice-versa for the right signal. In the centre position, both channels are fed at unity gain to the Mix bus. The balance control also affects the L-R balance within the mono sum

sent to the Aux sends (pre or post fade) or group busses.

The C (mono) bus is always fed directly with a mono sum of the stereo post-fader signal.

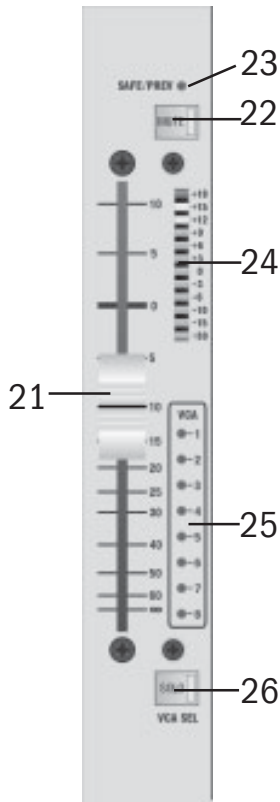

## Fader

A high-quality long-throw 100mm fader (21) controls the level to all busses, and has 10dB of gain when fully up as well as an expanded scale around the critical unity gain area for maximum resolution.

## MUTE

The MUTE switch (22) mutes the signal to all busses, including pre-fade Aux sends. The mute circuit can also be activated by the mute group system, an SIP mute signal, a VCA mute signal or internal snapshot control from the scene computer. A Preview mode allows editing and checking of mute groups and snapshots without disturbing the audio passing through the desk, and Mutes can be set 'Safe'.

## SAFE/PREV LED

The SAFE/PREV LED (23) is used to indicate the Mute Safe status of the channel or Preview mute status, if the console is in Preview mode. The channel is toggled in or out of SAFE mode using the MUTE switch, after first engaging EDIT SAFES mode on the master CPU panel. Steady illumination of the LED indicates a mute safe condition. Preview status is indicated by flashing illumination, upon entering Preview mode from the master module, if the Mute is present in the previewed mute group or scene.

## LED Input Metering

The Stereo channel channel is fitted with a 12-segment LED bargraph meter (24), positioned next to each fader for maximum visibility and giving immediate graphic indication of incoming signals at the insert return.

## VCA Assign LEDs

The module is assigned to the 8 VCA Groups using the SOLO button (26) on each channel, in conjunction with the VCA Master SOLO switches. The whole console has to be switched into the VCA Assign Mode (press the "VCA Assign Mode" switch located at the top of the master cpu panel) in order for the SOLO switch functions to be changed in this way. The current VCA assignments are indicated on the 8 VCA Assign LEDs (25) adjacent to the fader.

## SOLO

The Solo button (26) provides a stereo PFL feed to the engineer's headphones or monitors, or triggers a destructive solo in place, depending on mode selection at the master section. The solo button can also be activated remotely from a VCA solo when assigned to a VCA group, giving Stereo AFL. Intercancel or additive soloing is possible, with or without input priority, and solos can be cleared with a single button press at the master section.

## Stereo Input Rear Connector Panel

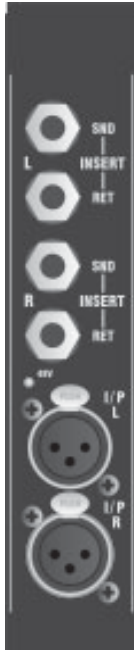

### LEFT, RIGHT INPUTS (3-pin female XLR)

Pin 1	Ground
Pin 2	Signal Hot
Pin 3	Signal Cold

### LEFT, RIGHT INSERT SEND (1/4" TRS Jack)

Tip	Signal Hot
Ring	Signal Cold
Sleeve	Ground

### LEFT, RIGHT INSERT RETURN (1/4" TRS Jack)

Tip	Signal Hot
Ring	Signal Cold
Sleeve	Ground

Note: the small hole in the rear panel below the Input XLRs is to allow factory adjustment of the module's internal VCA elements. No further adjustment of these is required or should be attempted, unless the VCA elements are replaced during servicing.

## Solder Link Options

The MH3 contains some optional links which allow certain internal signal feeds to be changed to suit user preference. For maximum reliability these are solder links, rather than push-on jumpers, in most cases.

Each link has its function identified by text on the pcb.

To change the default setting it is necessary to remove a zero-ohm resistor which sets the default routing, and then create a solder bridge between the relevant pair of solder pads. Once the resistor is removed it can be discarded. A second pair of solder pads adjacent to the resistor allows the default setting to be restored if required.

Function	Options	Default
Aux PRE source L	muted pre or post-EQ	muted post-EQ (R42)
Aux PRE source R	muted pre or post-EQ	muted post-EQ (R63)

# Output Section

## Overview

The Output Section is split into two modules. The fader panel below these output modules contains the 8 VCA master faders and a separate CPU Module which houses controls for snapshot automation, mute groups, and solo modes. The layout of the output section is clear and offers excellent flexibility as well as numerous facilities.

The Group/Return module controls the first 8 Aux Outputs, the 8 Group Outputs, plus 8 Stereo FX Return inputs.

The 8 faders on this module can control *either* Group or Aux Outputs, depending on recessed switch settings –this is the key to the dual purpose capability of the MH3.

The Master/Matrix module houses the remaining 4 Aux Outputs (Aux 9-12), which are always controlled by faders, plus the 4 Matrix outputs, and all the Master facilities including LCR master faders, monitoring and talkback.

At the top of both modules, 12-segment LED bargraph meters monitor the output levels. The main LCR outputs incorporate higher resolution 24-segment meters.



# Group/Return Module

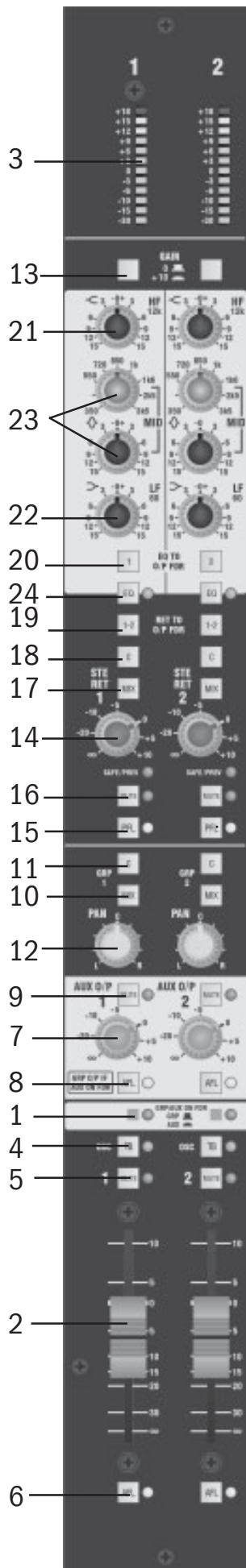

## Group and Aux Outputs with Swap facility

The key to the dual-purpose capability of the MH3 is the reversible signal path which allows either the Group or the Aux Output signal to be controlled by a linear fader, and have access to an insert point.

For FOH applications, the groups are required on faders for subgrouping duties, and the insert point allows external EQ or dynamics to be used on the group. The Aux sends in this application will be used for FX sends, so rotary master controls are appropriate.

By pressing the recessed GRP/AUX ON FDR button (1), thereby changing it to AUX mode, the console is set up for Stage Monitor use, where the Aux Output is controlled by the fader, and has use of the insert point for EQ insertion. Meanwhile the group output is swapped to the rotary fader.

It is possible to swap the fader mode for each of the 8 outputs individually, allowing a combination of subgroups and monitor sends on faders. This flexibility is essential when doing monitor mixes from FOH.

## Fader Output Section

Each of the 8 Fader master sections comprises a 60mm fader (2) which feeds either the Group or Aux signals to their respective balanced XLRs on the rear panel. A pre-fade balanced insert point, via separate 1/4" jacks, allows insertion of EQ or dynamics. Each fader knob is colour co-ordinated with its Aux bus send control for easy identification when controlling Monitor mixes, and the 12-segment bargraph meter (3) at the top of the module provides line-of-sight metering of any fader-controlled output.

The TB (osc) button (4) routes talkback, tone or pink noise from the central talkback/oscillator section to whichever output is being controlled by the fader.

Illuminated Mute (5) and AFL solo (6) buttons are provided for each fader.

If stereo subgroups or In-Ear sends are in use, the AFLs can be linked as a stereo pair by pressing both adjacent buttons at the same time; when linked, the AFL appears as a stereo AFL in the stereo wedge & phones outputs. Once a pair of AFLs are linked they stay linked until the two AFL buttons are pressed simultaneously again. Linked pairs remain linked even if the console is powered down and then powered up again.

## Rotary Output Section

Each of the 8 Rotary master section is equipped with a colour-coded rotary fader (7), and AFL solo (8) and MUTE (9) controls. (AFL stereo linking is not available on the rotary output section.)

## Group to Mix Section

The Group signal path, regardless of whether it is controlled by the fader or not, can always be routed to the main mix busses using the MIX (10) and C (11) switches and the PAN (12) control.

## Stereo FX Return with flippable EQ

Located above each Group/Aux Output section is a stereo FX return section. A stereo line input from balanced rear panel jacks is fed via a 0-10dB gain switch (13), via a stereo 3-band EQ section (see below) to a rotary level fader (14).

Illuminated Stereo PFL (15) and Mute (16) switches are provided.

The stereo return signal can be routed to the main MIX (17) and C (18) busses, or directly to the nearest pair of Output faders directly below the return, using switches 1-2, 3-4, 5-6 or 7-8 (19). This gives the following benefits to the return in addition to standard FX return to the main mix:

In Monitor applications when a pair of Output Faders will be controlling a stereo In-Ear feed, the return can provide an individual FX return for that mix.

Alternatively, if all 8 subgroups are not being used in a FOH application, the return can be routed to the output Faders and then to Mix, allowing control of the return level by linear faders.

## EQ

The 3-band EQ section is normally part of the FX return signal path, in which case it operates as a stereo EQ.

Alternatively, the EQ can be flipped into the Output Fader signal path, using the EQ TO O/P FDR switch (20), where it can be used to provide additional sweetening on In-Ear feeds or subgroups. In this case, each EQ stage functions as a mono EQ, associated with the corresponding Output Fader directly below it. The FX Return section continues to operate as before, but without EQ.

The EQ section comprises fixed shelving HF (21) and LF (22) bands, at 12kHz and 60Hz respectively, with a swept mid band (23) from 350Hz to 3.5kHz. The mid band Q is fixed at 1.1. 15dB of cut or boost is available on all bands.

The EQ can be switched in or out using the illuminated EQ switch (24).



## Rear Connector

### INSERT SEND & INSERT RETURN, GRP/AUX (1/4" TRS Jack)

Tip	Signal Hot
Ring	Signal Cold
Sleeve	Ground

### STEREO FX RETURN L & R (1/4" TRS Jack)

Tip	Signal Hot
Ring	Signal Cold
Sleeve	Ground

### GROUP & AUX OUTPUTS (3 pin male XLR)

Pin 1	Ground
Pin 2	Signal Hot
Pin 3	Signal Cold

Note: mono signals can be connected to the Left input jack and this will automatically be fed to both sides of the stereo return.

# Master/Matrix Module

## Aux 9-12 Outputs Section

Aux Outputs from 9-12 have their own dedicated output section and are always controlled by linear faders.

Each fader (1) feeds the Aux signal to balanced rear-panel XLR outputs. There is a pre-fade insert point with separate jacks, and TB (osc)(2), Mute (3) and AFL (4) buttons are provided.

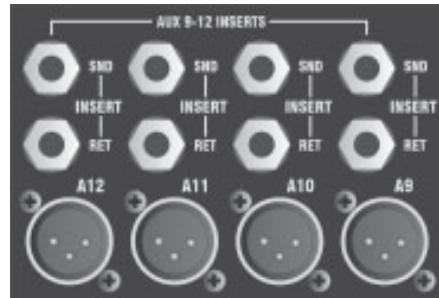
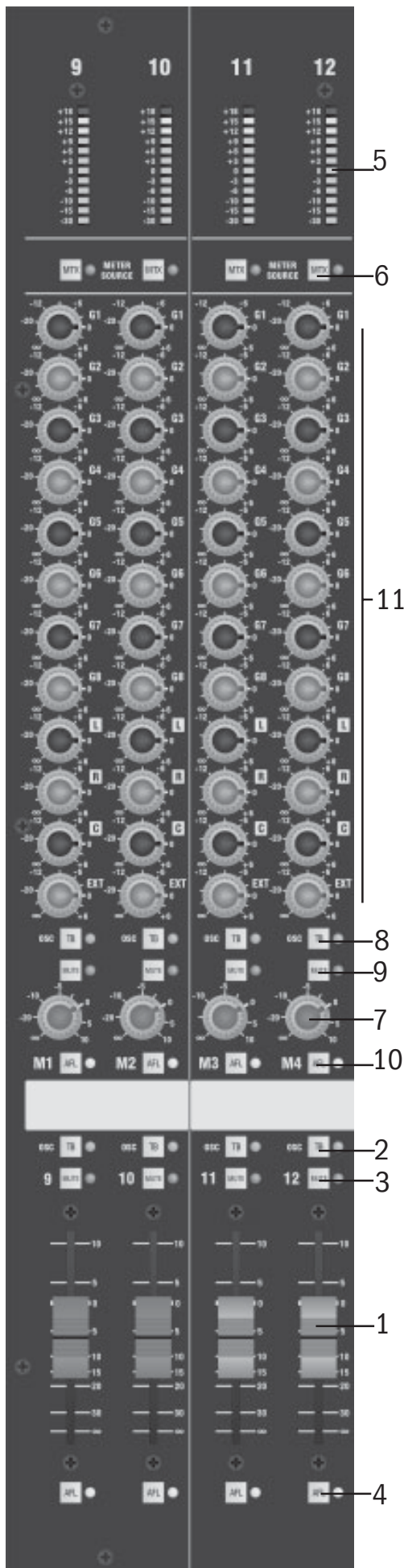

The 12-segment LED bargraph meters (5) at the top of the section normally meter the Aux 9-12 Outputs, but can be switched to meter the Matrix Outputs 1-4 by pressing the MTX buttons (6) below the meters.

## Matrix 1-4 Outputs Section

A 12x4 Matrix section is located immediately above Aux 9-12 Outputs. Each of the 4 Outputs has a rotary master fader (7), with TB (osc)(8), Mute (9), and AFL (10) buttons, and 12 receive knobs (11) control the mix levels fed to that Matrix Output from each of the 8 Groups, the L,R and C main outputs, and an external line input from a rear panel 1/4" balanced jack. The Matrix Output signal itself appears on a balanced XLR on the rear panel. The Matrix capability can be expanded to 8 Outputs if required, by fitting the optional 4 Mtx +4 Input module, in place of the 8-way input module to the immediate right of the Master/Matrix module.

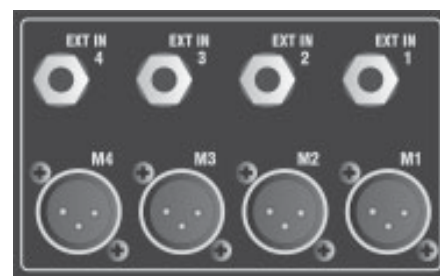

## Rear Connector Pinouts

**INSERT SEND, INSERT RETURN & EXT IN (1/4" TRS Jack)**

Tip	Signal Hot
Ring	Signal Cold
Sleeve	Ground

**AUX & MATRIX OUTPUTS (3 pin male XLR)**

Pin 1	Ground
Pin 2	Signal Hot
Pin 3	Signal Cold

## Master Section

The remaining section of the Master/Matrix module contains the main L, R and C output faders, Alternate stereo mix output, a noise or sine wave test oscillator, and internal/external talkback functions. This section also contains the monitor outputs, 2-Track return and monitor source controls.

### Main Output Faders

Three 100mm high quality faders (1) control the Stereo Mix Left and Right and Centre (Mono) Mix output levels. These are fed to balanced XLRs on the rear panel. The Centre fader can be used to control the 'Monitors' level for feeding wedges in a stage monitor application by pressing the 'Use C Fader' button (2). The Centre output level will then be controlled by the rotary MNTR control.

### Alternate stereo mix output

The ALT output is an additional stereo output, switchable pre or post (3) the MIX master faders and controlled by the ALT STE rotary fader (4). The outputs appear on balanced XLRs on the rear panel. Both L and R outputs can be fed by a mono sum of the MIX L and R signals using the MNO switch (5), effectively giving two fader controlled mono-sum mix outputs.



### Insert Points

Pre-fade MIX L, R and C (mono) insert points use balanced sends and returns on separate 1/4" jacks on the rear panel.

### Talkback and Oscillator section

The talkback and oscillator sections share a common set of TB (osc) routing buttons, allowing them to access any of the Fader-controlled outputs and the Matrix outputs.

The talkback section has a front panel XLR (6) for mic input, with adjustable gain from 20-50dB (7). (48V phantom power is available via an internal jumper).

The mic signal can be routed either to selected internal busses, by pressing the INT button (8) together with the appropriate TB(Osc) button(s), or sent to a proprietary intercom output (compatible with Soundcraft MH4, Series FIVE and SM-Series consoles) using the EXT button (9). The INT and EXT buttons are momentary if pressed for more than 0.5 seconds, otherwise they are latching.

The Oscillator generates either tone, from 55Hz to 11kHz (10), or pink noise (11). It has a Level control (12), and its own independent balanced XLR output on the rear panel. The oscillator signal is routed to its XLR via the EXT switch (13). It is routed to internal console busses by pressing the OSC TO BUSSES switch (14) and the local TB (osc) switches on the desired output. The TB/Osc switches for the MIX (15) and C busses (16) are located adjacent to the OSC TO BUSSES switch.

### PSU Status Indicators

Three red PSU Status LEDs (17) indicate normal PSU rail operation.

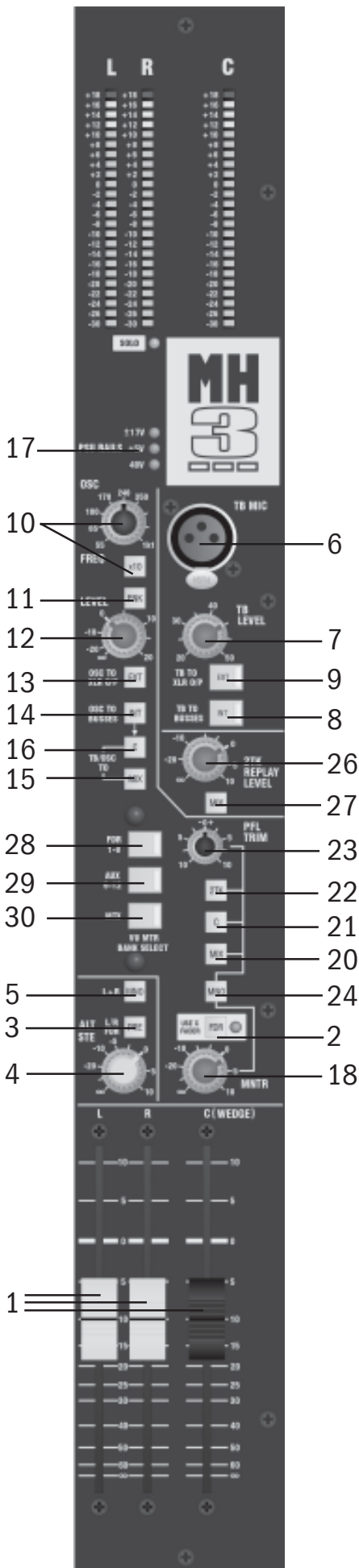

## Monitor and Headphones Outputs

Separate level controls (18 & 19) are provided for engineer's monitor speakers and headphones. The signal source for these outputs is common and can be selected from the post-fade MIX signal (20), the Centre (mono) MIX signal (to both L and R outputs)(21), or the 2TK replay inputs (22), and may be summed by simultaneous selection if required. These sources are automatically overridden by an input or output solo signal. The level of the PFL or AFL signal can be adjusted by +/-10dB using the PFL/AFL TRIM control (23).

The Monitor level rotary control can be swapped with the Centre Output master fader, by pressing the 'Use C Fader' button (2) adjacent to the rotary control.

The stereo Monitor/phones signal can be summed to mono if required by pressing the MNO button (24).

The headphones output socket is a stereo 1/4" jack (25), discretely mounted in a recessed socket in the fader panel fascia; the phones Volume control (19) is located adjacent to the socket. The headphone amplifier has a high power capability, and is designed to deliver its full output voltage even into low impedance (e.g. 8 ohm) phones.

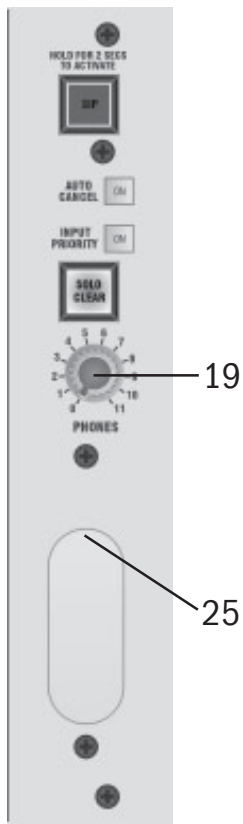

## 2-Track Replay Input

For replay of stereo tape, CD or Minidisc sources, a rotary level control (26) adjusts the signal level from the balanced 1/4" jack stereo inputs. These can either be routed to the MIX bus with the MIX switch (27), or monitored on the monitor/phones outputs as described above.

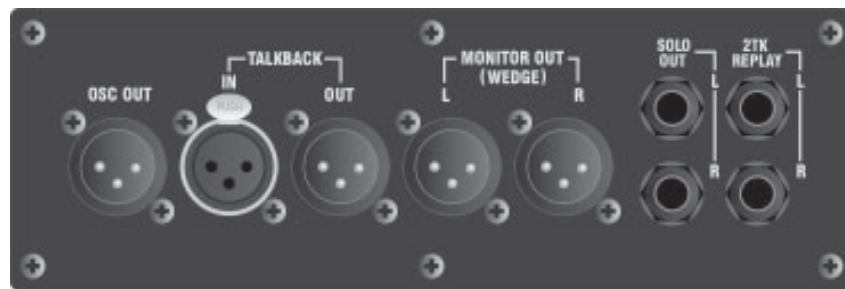

## Optional Meterbridge Controls

The optional buttons, FDR 1-8, AUX 9-12 and MTX are used if the optional VU Meterbridge is fitted.

Three large VU meters with integral Peak LEDs meter the Mix left, right and Centre output signals. If the meterbridge is not fitted, these switches are covered by a (removable) blanking plate.

The Meterbridge features a bank of 8 medium-size VU meters are switched to meter one of three banks of sources, using the FDR 1-8 (28), AUX 9-12 (29) and MTX (30):

The FDR 1-8 switch selects the signals from Aux/Group Faders 1-8 to be fed to the 8 meters.

The AUX 9-12 switch selects the Aux 9-12 signals to be fed to the first 4 meters.

The MTX switch selects the Matrix 1-4 signals (and 5-8 if the optional matrix expander is fitted) to be fed to the 4/8 meters.

The three switches are interlocked.

# Automation CPU Panel

The automation computer section occupies the fader panel area between the VCA Master faders and the Master Monitor/Phones controls.

The functions of this section are:

- **Mute Scene Automation**

128 Mute Scenes with MIDI Program Change, Insert, Store, Recall, Next, Up/Down, 7-segment display with Preview Edit. Scenes can also store VCA assignments - refer to VCA ASSIGN section below.

- **8 Mute Groups with Preview Edit**

- **8 VCA Groups with Master Mutes & VCA Solo**

- **Solo System**

AFL/PFL control, SIP, Solo Clear, Input Priority, Auto-cancel

- **Safe System**

Safe from Scenes, Mute Groups, VCA Master Mutes, MIDI Mutes & SIP Mutes

- **Preview System**

Allows preview & edit of Scenes and Mute Groups

- **MIDI System**

Mute control via Note On/Offs. Scene control via Program Change. System Exclusive Dumps. 'BSS Varicurve MIDI loop' support. dbx 'Driverack 480' Output AFL sysex protocol support.

- **Cascade System**

Linking 2 consoles automation & solo logic via RS232

- **Miscellaneous**

User modes for Recall VCA assignments in scenes, Recall mutes in scenes, Transmit Program Changes on/off, Mute Groups as scene shortcuts, Auto increment on scene recall, MIDI automation Note Mode, Hard Reset

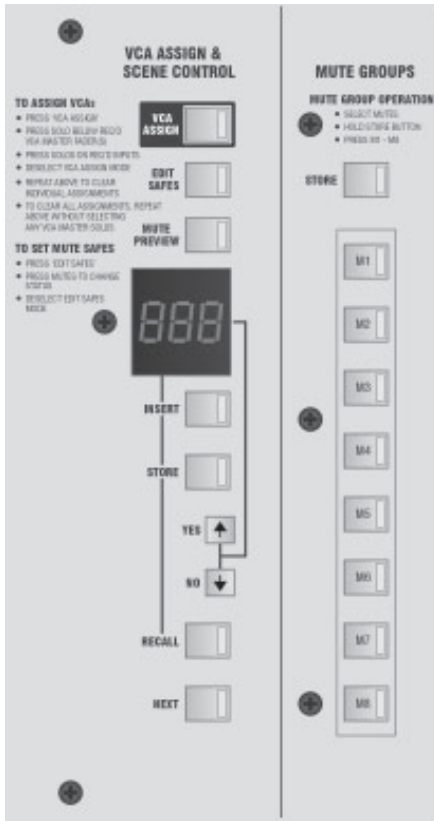

# Assignment controls

## VCA ASSIGN

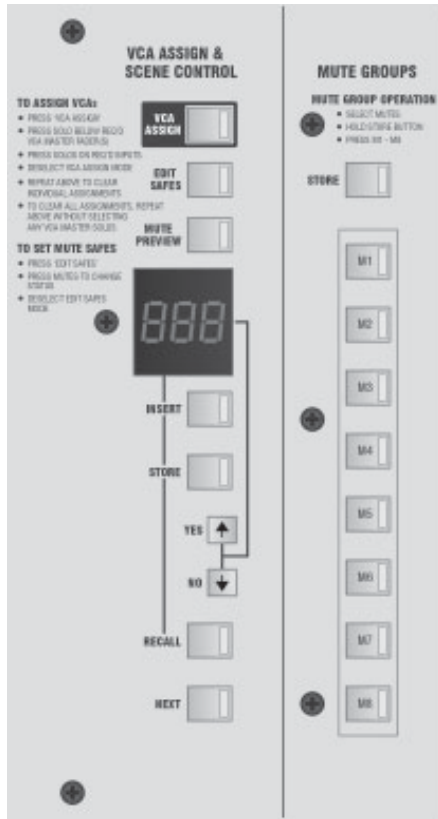

The VCA ASSIGN switch selects VCA Assign mode. To assign channels to VCAs, first press the VCA Assign Mode switch, then the SOLO buttons on one or more VCA master faders -these SOLO buttons start flashing. Then press the SOLO buttons of any channels required to be part of those groups. The VCA Assign LEDs on the channels illuminate to indicate the assignment. The assignments can be deselected by a second press on the channel SOLO button -this then acts like a toggle for assigning and de-assigning. When finished, press the VCA Assign mode switch again to turn off the flashing and lock the assignments. (This will happen automatically if no solo buttons are pressed for a period of 20 seconds.)

To deselect any individual assignment, repeat the procedure for assigning to the VCA is question: pressing the channel SOLO switch on a channel which already is assigned to the selected VCA, will de-assign it.

To clear all assignments from a particular channel, enter VCA ASSN mode, but do not select any VCA master solos. Pressing input Solos in this condition will clear all the assignments from those inputs.

Note: VCA assignments are stored in scenes, but recall is disabled by default, to avoid accidental changes to the programmed assignments. To enable scene recall of these, see the section on "User Modes" later in this manual.

## EDIT SAFES

EDIT SAFES mode allows the MUTE buttons on inputs and outputs to be used to set those channels into SAFE mode. This means that their mutes will not be affected by any mute group, scene mute or solo in place mute, but can still be manually muted. The SAFE/PREVIEW LED adjacent to the MUTE switches will illuminate steadily to show that the mute is in SAFE mode. Putting a channel into Mute Safe will also unmute the channel, if it is muted as a result of anything except a manual press.“

## MUTE PREVIEW

MUTE PREVIEW mode allows checking of the mute contents of a scene or mute group, in the following way. When Preview mode is active, recalling a scene or mute group will display the muted status of that scene or mute group by flashing the SAFE/PREVIEW LED, instead of actually muting the channel or output. In addition, pressing the MUTE switches can be used to edit the recalled scene or mute group, and it can then be re-stored or overwritten to the current scene, or another scene. Pressing the Mute Preview switch will toggle in and out of preview mode.

Note that the mute safe status of channels cannot be seen whilst Mute Preview mode is active because the same LED is used.

No MIDI control to or from the console is possible when Preview Mode is active.

# Mute Groups

## Mute Group Master switches

Up to 8 Mute Groups can be created and controlled from the 8 Mute Master switches.

In a special mode (accessible using User Modes -see later) the function of the Mute Masters can be changed so that they become 'Instant Recall' or 'Shortcut' keys for any of the 128 mute scenes. In this mode, Mute Groups are not available.

The Mute Group Master switches are used to select or change 'User Modes' whilst the console is powering up -see later on User Modes.

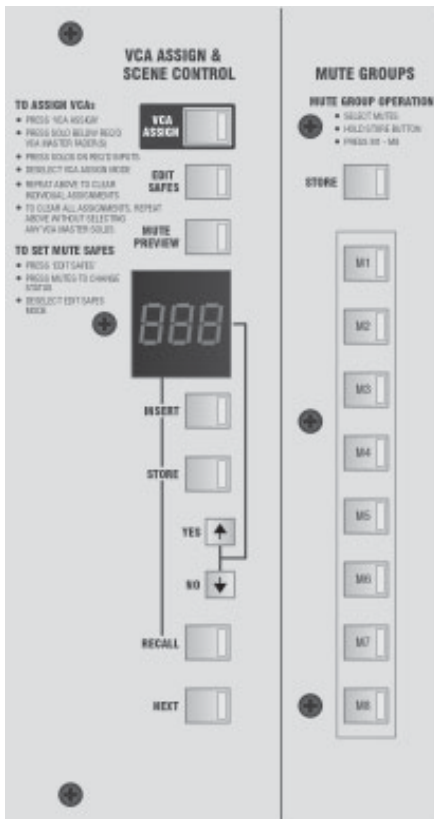

## Mute Group Masters in Mute Groups Mode (default mode)

To store a Mute Group, first switch on the Channel or Output Mutes required, then hold down the STORE switch immediately above the Mute Master switches and press the desired Mute Master switch.

Mute Groups can be set up, edited and tested in Preview mode, the procedure is the same, the only difference is that pressing the Mute switches will not actually mute the channels, and the Mute status will be shown on the flashing preview LEDs, rather than the switches themselves.

The following notes apply to Mute Groups:

- Channels or outputs will not mute if they are Safe.

- They will not unmute if they are also Muted as the result of another active Mute Group or VCA Group (inputs only), or if they have been manually muted.

- A Mute Group Master will not activate if no channels have been assigned to it or all its members are safed.

- An active Mute Group will be automatically deactivated if at any point all its members are made safe, if all its members are unmuted, or if it is made to have no members.

## Mute Group Masters as Scene 'Shortcuts' (User Mode 1 - Mute Group Masters as scene shortcuts - active)

Normally, User Mode 1 is not active and the Mute Masters function as Mute Groups.

If User Mode 1 (Mute Group Masters as scene shortcuts) is active, pressing a Mute Group Master will recall the scene assigned to that Mute Group. If in preview mode, pressing a Mute Group Master will preview-recall the scene assigned to that Mute Group.

To assign a scene to a shortcut key, first select and recall the required scene number using the Up/Dwn and Recall switches, then hold down the Store switch above the Mute Masters, and press the required Mute Master switch. The console is supplied by default to have Scenes 1-8 assigned to Mute Masters 1-8.

# Scene Control Section

## Scene Automation

### 7-Segment Display

The 3-digit display with decimal points normally shows the scene number. The display also shows the software version number on power up, scene store prompts, and error messages.

The three decimal points all flash if the current mute settings or VCA assignment settings (if User Mode 3 is active) do not match last recalled scene. In preview mode, the three decimal points all flash if the current preview-mute status does not match last preview-recalled scene.

### YES/ NO (↑/↓) Switches

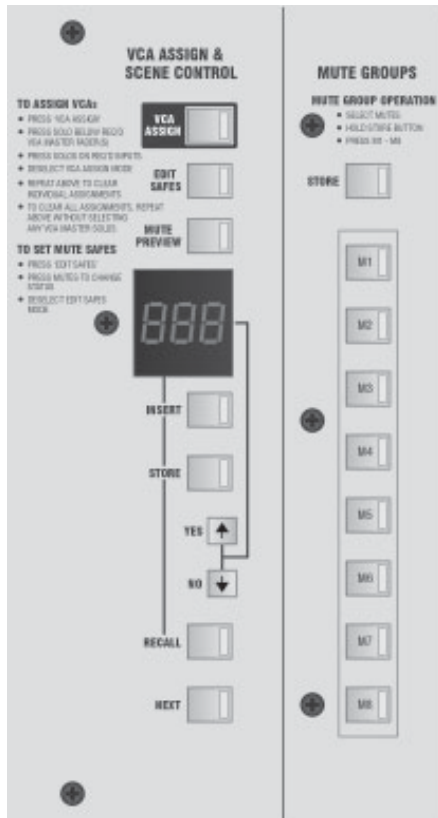

Used to scroll through the scenes. Holding down the keys will gradually scroll faster (auto-scroll). Pressing ↑/↓ while Recall is being held down will scroll the scene and recall it, but not if the display is auto-scrolling. The YES/NO facility is used to confirm or cancel Store or Insert actions.

The switch LEDs light alternately with Store & Insert switches during a Store or Insert <yes><no> operation.

### Recall Switch

Used to recall the scene number displayed. If held down, the ↑/↓ keys can be used to scroll through & recall scenes.

The switch LED lights when the current displayed scene is not the last recalled scene (and in Preview mode if current displayed scene is not the last preview recalled scene).

### Next Switch

Used to recall the currently displayed scene plus 1. It does not work with ↑/↓ keys as per the Recall switch, but instead allows automatic sequential recall of scenes when repeatedly pressed.

### Store Switch

Used to store the current mute settings and VCA assignments over the scene number displayed. When pressed the display will show <scene number><yes><no>. The Store/↑/↓ LEDs will flash alternately. Press ↑(Yes) to store the scene. Press ↓(No) to cancel the store operation.

### Insert Switch

Used to store the current mute settings at the scene number displayed and shuffling all the higher number scenes up by one. Note that this means that any scene data stored in scene 128 will be lost! When pressed the display will show <scene number><yes><no>. The Insert/↑/↓ LEDs will flash alternately. Press ↑(Yes) to insert the scene and erase any data in scene 128. Press ↓(No) to cancel the insert operation.

# User Modes

There are 6 special User Modes that allow the functionality of the console to be customised according to user requirements. These are designed to be things that don't need to be changed very often. Once set, the User Modes are memorised on subsequent power down, so only have to be set once.

The current status of the User Modes for the console is displayed for approx. 2 seconds by illumination of the Mute Group Master LEDs during power up.

If an LED is lit during power-up, that mode is active.

To toggle a user mode on/off, hold the relevant switch(es) down during power-up, until its internal LED changes state. The modes are as follows:

<b>Mode</b>	<b>Function</b>	<b>Factory Default</b>
1	Mute Group Masters as scene 'shortcuts'	Not enabled
2	MIDI Note Mode: enabled = sequencer, not enabled = sampler	Not enabled
3	Scene Recall VCA Assign On	Not enabled
4	Scene Recall Mute update Off	Not enabled
5	Scene Recall MIDI Tx Program Change Off	Not enabled
6	Scene RECALL auto-increment On	Not enabled

## Application Notes:

### **Mute Group Masters as Scene Shortcuts On/Off**

Normally the Mute Masters function as Mute Groups, and much of the time in Rock and Roll type production the Mute Groups will be used exclusively, with little use of the Scene automation.

However, if more intensive use of scene-based automation is required, it can be convenient to have short-cut keys to jump to key scenes, instead of mute groups.

### **Midi Note Mode -Sequencer/Sampler**

The most likely application of the midi control from mute switches will be triggering of sound effects via a sampler, so this mode is enabled by default. If it is required to dynamically automate the mutes, this can be done by recording the mute presses to a midi sequencer-in this case Sequencer mode must be selected.

### **Snapshot VCA Recall On/Off**

This is disabled by default as it is a potentially dangerous mode, particularly for normal rock and roll type applications, where the scene automation is not being used. Accidental pressing of the Recall or Next switches could then result in the current VCA assignments being unassigned during a performance, so this function is disabled. For theatrical applications it can be useful to have VCAs change their assignments with scene changes -if this is required VCA Recall can be enabled.

### **Snapshot Recall Mute Update On/Off**

Normally, recalling scenes automatically recalls the stored mute settings, as well as sending out a midi program change message. However, there may be times when you want to send the midi program changes but NOT have the mutes continually being reset. Switching off the mute recall allows the scene control section to be used as a remote control for MIDI FX, without affecting console mutes.

Mute Groups remain fully operational when scene mute recall has been disabled.

### **Scene Recall MIDI Tx Program Change On/Off**

In some circumstances it may be necessary to inhibit the sending of MIDI program changes when recalling scenes -for example, if program changes are not being used to recall patches on FX units, but channel mutes are being used to trigger sound FX samples, the program change may disrupt the operation of the sampler.

### **MIDI In, Out & Thru Rear Panel Connector**



# Power Down Settings

The following settings are saved to EPROM on power down and will be restored when the console is powered back up:

- Active mutes
- Manual mute status
- Active Mute Groups (if User Mode 1 inactive)
- Active VCA Groups
- VCA Assign Membership
- Active safes
- Mute Group Shortcuts (if User Mode 1 active)
- Output AFL 'pairing'
- Last Recalled Scene
- User Settings

# Resetting the CPU

## CPU Reset

In order to change User Modes without powering the console down, or in the unlikely event of a CPU crash, it can be re-booted whilst the power is switched on. The scene, mute group and VCA assign memories will be unaffected by this procedure.

### **Press & hold EDIT SAFES + YES + NO**

The CPU will be reset, and will follow the same boot-up sequence as when the console is powered up.

In the event of a serious CPU malfunction, it is possible to force the CPU to reboot by pressing an internal switch on the CPU pcb itself. This is accessible in an emergency by removing the screws holding the CPU fascia to the console, and carefully lifting the CPU assembly out of the console until the large CPU pcb, which lies flat at the bottom of the assembly, can be reached. The reset switch is visible on the top side of the board, towards the centre of the front edge of the pcb.

## Hard Reset

Note: Before performing a Hard Reset, ensure that the scene memory has been backed up using a MIDI dump, as all saved data will be erased.

### **Press Store + Recall on power up to perform a Hard Reset.**

A hard reset clears out all saved data, restoring the 'factory defaults'. All scenes will be 'empty' (i.e. no mutes/VCA assignments), all mute groups will be 'empty', all User modes reset, all mutes/safes reset etc.

# Dumping and Reloading the Internal Memory

The console uses standard MIDI Sys-Ex protocol to allow saving and reloading of the scene memory to any MIDI device which can receive, save and transmit Sys-Ex data.

## Transmitting a SysEx Dump

A Dump Out can be generated either by pressing, all at the same time **YES + NO + Recall** on the master panel, or by requesting a dump with a Dump Out Request Sys-Ex message.

During the Dump Out, the display will flash '\_do'. 128 scene packets followed by a Mute Group Assignments packet will be transmitted.

### Notes:

A Dump out can only be initialized when in normal mode (i.e. not scrolling/in Store/Insert modes), and will not be initialized if currently dumping in.

During Dump Out all scene/mode automation is disabled. On completing the dump, the console will return to normal operation, displaying the current scene as usual.

During a dump out, no MIDI mute messages will be transmitted, and any incoming MIDI messages will be ignored.

## Receiving a SysEx Dump

For simplicity of operation, the console will automatically accept a dump in, when it receives valid data in the form of one of its own midi dumps. It will not respond to any other type of Sys-Ex dump.

On receiving a valid sysex packet, the MIDI Dump In will be carried out. The display will flash '\_di' during the dump.

Each packet is received, decoded & checked, and if there are no checksum or other errors the data will be written to EEPROM. If there are problems an error message will be displayed.

The console will revert to normal operation if no further sysex message is received 1 second after receiving the previous sysex message.

During a dump in, no MIDI mute messages will be transmitted.

### Notes:

Any packets can be received in any order.

On receiving a valid Dump Sysex Packet the console will enter Dump In mode.

Dump In mode won't be entered for a Dump Request SysEx.

A Dump In will be ignored if in Preview/SIP Active modes, or if currently dumping out.

# Console Linking Option

The console can be fitted with an optional linking module, with both audio and logic interfaces provided for connecting a second 'slave' console when more input channels are required. (Note that only two consoles can be linked, and each one must be fitted with a linking module).

## Installing The Optional Linking Module

Remove the 10 screws from blank panel, which is to the right of the MIDI connector panel, and remove the panel.

Inside the console you will find 2 ribbon cables ( a 26-way to the left and a 50-way to the centre) and an earth wire. Attach the cables and earth wire to the Linking module. Using the screws which held the blank panel in place, secure the linking module to the console.

On the MIDI rear connector pcb there are 8 dip switches, these will have to be moved to the OFF position. You may have to temporarily remove the MIDI board to gain access to the DIP switches. Replace the MIDI pcb.

A linking module must be fitted to each of the two consoles that you want to link.

## Audio Linking

Audio linking is accomplished by simply connecting the main outputs (group, aux, mix, solo etc) of the slave console to the corresponding bus inputs of the master console, using a female XLR to 1/4" jack multicore. A 25-way multicore is required.

## Logic Linking -VCAs, Mute Groups and Solos

A 15-way proprietary link cable is used to link the VCAs and other facilities.

This is compatible with Soundcraft MH4 consoles.

Linking of the VCAs is done using a parallel interface with VCA bus inputs on the TO MASTER connector, and outputs on the TO SLAVE connector.

Master/slave designation will depend on which way round the cable is connected:

i.e., connect TO MASTER of the Slave console to TO SLAVE on the Master console.



The Mute Groups, Solos and automation of two consoles are linked by means of an RS232 serial connection within the 15-wy proprietary link (referred to below as the 'Cascade Cable'), joining the internal CPUs of both consoles.

**The consoles must be linked at boot up.** The console checks for the presence of a cascade cable at its cascade port at boot-up. From this it determines whether it is a 'Master standalone', 'Master Cascadable', or 'Slave Cascadable' console.

A link is automatically established when two consoles linked with a cascade cable are booted up. When the link is established the slave console inherits the master console's settings. The slave display will flash 'SLA' until synchronisation with the master is (automatically) achieved.

Once linked, all Automation operation from the slave console is disabled\*, except for SIP, Auto Cancel, IP Priority & Solo Clear, which function mutually inclusively with the respective master

console controls. This means that solo control is global and can be activated from either the master or slave console. Automation behaviour is identical over cascaded consoles as for a standalone console.

**\*The one exception to this is for initiating a MIDI Dump Out - If UP, DN and Recall are pressed simultaneously on the slave console, a (local) MIDI Dump Out will be initiated.**

A link will not be established unless master console is in normal mode (i.e. not in Edit Safes/Preview/VCA Assign/SIP Active/Dump In/Dump Out mode). All active solos will be cleared on both consoles on establishing a link.

## Link established: Synchronizing Console Settings

The slave now updates the seven-segment display to the same as the master console. Any relevant mutes are activated for members of any active VCA Master Mutes (flashing), plus any relevant mutes are activated for members of any active Mute Groups.

The master and slave console are now fully synchronized, and are in Normal State, ready for operation.

The linked consoles now remain in a linked configuration with a hello call-reply handshake every 10s. If the handshake times-out, all solos will be cleared on both consoles, and the slave console will return to normal mode (i.e. Edit Safes/Preview/VCA Assign will be exited). The slave console will revert to displaying 'SLA', waiting for the link to be re-established. During this time, only mute and solo automation is available on the slave.

If a link is re-established, the slave console once again inherits the master's console settings as above, and cascaded console operation continues once again. If a link is not re-established within 30s, both consoles will revert to being an independent Master console with full automation independently per console. This is to allow access to all automation functions on each console in the case of emergency where the link has been permanently severed. A link can now not be re-established without re-booting both consoles and re-establishing a link.

## Cascaded Operation

Once a link is established, all Scene, Mode, Mute Group and VCA Master Mute automation is carried out from the master console. The following switches/LEDs on the slave console will be unused at all times; i.e. depressing the switches will have no effect whatsoever, LEDs always half-brightness (except for initiating a MIDI Dump Out):

Edit Safes, VCA Assign, Preview

Insert, Store, Next, \*UP, \*DN, \*Recall

MG Store, MG Masters 1-8

VCA Master Mutes, VCA Master Solos, VCA Master Levels

(\*Exception: Pressing UP, DN and Recall simultaneously on the slave console initiates a local MIDI Dump Out).

The 7 segment display on the slave console always follows the master console, except during MIDI Dumps, where the dumping console displays '\_di' or '\_do', and the remote console displays '---'.

The solo automation controls, that is:

SIP, Auto Cancel, IP Priority, Solo Clear

are still active on both master and slave consoles. These features will function globally over both consoles, allowing solo control to be activated from either console. The solo automation controls hence are always kept consistent with each other over both consoles, i.e. activating the SIP switch on the master console will also invoke the slave console to enter relevant SIP mode

and to light it's SIP LED etc.

### **User Modes over cascaded consoles**

User modes can be configured independently per console. However, inherently, User Modes 1 (Mute Groups Recall Scenes), 5 (Program Change Tx OFF) and 6 (Recall Auto Increment) will have no affect on the slave console.

### **Solo Modes over cascaded consoles**

The solo mode (Normal, Input Priority, Input Priority + Auto Cancel, Auto Cancel) functions globally over both consoles. For instance, when Auto Cancel + Input Priority is On, Activating an input solo on the slave will cancel any other input solos on the slave plus cancel any input solos on the master.

### **Mute Group Operation over cascaded consoles**

All Mute Group automation is carried out from the master console. Relevant messages are automatically sent to the slave console invoking the slave console to update its settings to maintain synchronicity with the master console.

The Mute Group Master switches on the slave console are disabled.

### **VCA Master Mute/Solo over cascaded consoles**

All VCA Master automation is carried out from the master console. Relevant messages are automatically sent to the slave console invoking the slave console to update its settings to maintain synchronicity with the master console.

The VCA Master switches on the slave console are disabled.

### **Scene Automation over cascaded consoles**

All Scene automation (Scene UP, DN, Recall, Next, Store, Insert) is carried out from the master console. Relevant messages are automatically sent to the slave console invoking the slave console to update its settings to maintain synchronicity with the master console.

### **Mode Switching over cascaded consoles**

All mode switching (Edit Safes, Preview, VCA Assign) is carried out from the master console. Relevant messages are automatically sent to the slave console invoking the slave console to update its settings to maintain synchronicity with the master console.

## **MIDI Dumping over cascaded consoles**

### **MIDI Dump**

MIDI Dump (In/Out) will function locally for each console, ie the memory of each console remains separate, and both must be backed up separately.

When a console (master or slave) enters a MIDI dump (In/Out), a message is automatically sent to the other console, invoking it to enter MIDI Suspend state. In this state, all scene/mode automation is disabled plus the display shows '---'. When the console finishes dumping, a message is automatically sent to the other console, invoking it to exit MIDI Suspend state, returning to normal console operation.

## **MIDI Implementation over cascaded consoles**

### **MIDI Mutes**

The MIDI Mute implementation functions locally for each console.

Any MIDI mutes received at the console's MIDI In port will locally activate/deactivate mutes as usual.

All MIDI mutes associated with manual mute activation/deactivation will be transmitted via the local MIDI Out port as usual.

### **Scene Program Changes**

The MIDI Program Change implementation functions only on the master console.

Any MIDI program changes received at the master console's MIDI In port will recall scenes as usual.

Any MIDI program changes associated with scene recall (unless User Mode 5 active) will be transmitted by the master console's MIDI Out port.

Any MIDI program changes received at the slave console's MIDI In port will be ignored.

No MIDI program changes associated with scene recall will ever be transmitted by the slave console.

### **Dbx Driverack 480 AFL Protocol Solos**

The Dbx Driverack 480 AFL implementation functions locally for each console.

Any MIDI solo messages received at the console's MIDI In port will locally activate/deactivate AFL solos as usual.

All MIDI solo messages associated with manual solo activation/deactivation will be transmitted via the local MIDI Out port as usual.

### **BSS Varicurve MIDI Loop Mode**

The BSS MIDI Loop AFL implementation functions locally for each console.



# MH3 Typical Specifications

## Frequency Response

XLR input to any output ..... +0/-1dB, 20Hz-20kHz

## T.H.D. & Noise

All measurements at +10dBu

XLR in to Direct Out ..... <0.015% @ 1kHz

..... <0.02% @ 10kHz

XLR in to Mix Out ..... <0.015% @1kHz

..... <0.02% @10kHz

Mic Input E.I.N. .... <-128dBu (150 Ohm source)

22Hz-22kHz bandwidth, unweighted

Residual Noise ..... -95dBu

Mix Output; no inputs routed, Mix fader @0dB

Bus Noise ..... Mix Output, input faders @  $-\infty$ , Mix fader 0dB

..... 48 channels routed <-85dBu

..... Grp Output, input faders @  $-\infty$ , Grp fader 0dB

..... 48 channels routed <-85dBu

..... Aux Output, input sends @  $-\infty$ , Aux fader 0dB

..... 48 channels routed <-86dBu

## Crosstalk

1kHz, +20dBu input signals

Input Channel Muting ..... >95dB

Input fader cutoff ..... >88dB

Input pan pot isolation ..... >72dB

Mix routing isolation ..... >100dB

Group routing isolation ..... >99dB

Group-group crosstalk ..... <-92dB

Group-Mix crosstalk ..... <-100dB

Mix-Group crosstalk ..... <-100dB

Aux send off ..... <-80dB

## CMRR

Mono input ..... 85dB @ 1kHz

## Input & Output Levels

Mic Input ..... +26dBu max

Balanced Inputs ..... +21dBu max

Balanced Outputs ..... +21dBu max

Nominal Operating Level ..... 0dBu

## Input & Output Impedances

Mic Input .....	2k $\Omega$
All other inputs .....	>10k $\Omega$
Headphone Output .....	0.33 $\Omega$
Recommended h'phone impedance .....	4-600 $\Omega$
All other Ouptuts .....	<75 $\Omega$

## Oscillator

..... 55Hz to 11kHz/Pink Noise, variable level

## HP Filter (Mono Input)

..... 30-400Hz, 12dB per octave

## EQ (Mono Input)

HF: ..... 1kHz-20kHz, +/-15dB, shelving

Hi-Mid: ..... 750Hz-13kHz, +/-15dB, Q=0.5-3.0

Lo-Mid: ..... 75Hz-1.3kHz, +/-15dB, Q=0.5-3.0

LF: ..... 30Hz-500Hz, +/-15dB, shelving

## Metering

Internal 12-segment LED bargraphs for all inputs and Outputs (24-segment for L/R/C Outputs)

Optional VU Meterpod: 8 VU meters monitoring O/P Faders 1-8/Aux 9-12/Matrix 1-4 via bank selection, and L/R/C.

## Power Consumption

Mains Power: 56ch: 600VA max, 24ch 300VA max

48Ch console: each 17V rail takes 8.5A (nominal, measured with 4 Littlites connected), the 8V rail takes 0.2A (nominal).

## Weight

24 Ch ..... 68kg (150lb)

32 Ch ..... 80kg (176lb)

40 Ch ..... 92kg (202lb)

48 Ch ..... 103kg (227lb)

56 Ch ..... 115kg (253lb)

## Operating Conditions

Temperature Range ..... -10° to +30°

Relative Humidity ..... 0% to 80%